

PARC EOLIEN DE LA BACOULETTE (02)

Demande d'Autorisation Environnementale (DAE)

Cahier n°11 - Plan masse



Rapport final - Version 1

Dossier 19110013-V1
22/06/2021

réalisé par



Auddicé Environnement
ZAC du Chevalement
5 rue des Molettes
59286 Roost-Warendin
03 27 97 36 39

PARC EOLIEN DE LA BACOULETTE (02)

Demande d'Autorisation Environnementale (DAE)

Cahier n°11 - Plan masse



Rapport final - Version 1

FERME EOLIENNE D'EBOULEAU SAS

Version	Date	Description
Rapport final - Version 1	22/06/2021	Cahier n°11 - Plan masse







	Nom - Fonction	Date	Signature
Rédaction	ELOIRE Julien – Ingénieur environnement	22/06/2021	
Validation	ELOIRE Julien – Responsable service Aménagement du Territoire	22/06/2021	

TABLE DES MATIERES

CHAPITRE 1. PLAN MASSE	5
------------------------------	---

CHAPITRE 1. PLAN MASSE

AU3 - 1
Plan de situation



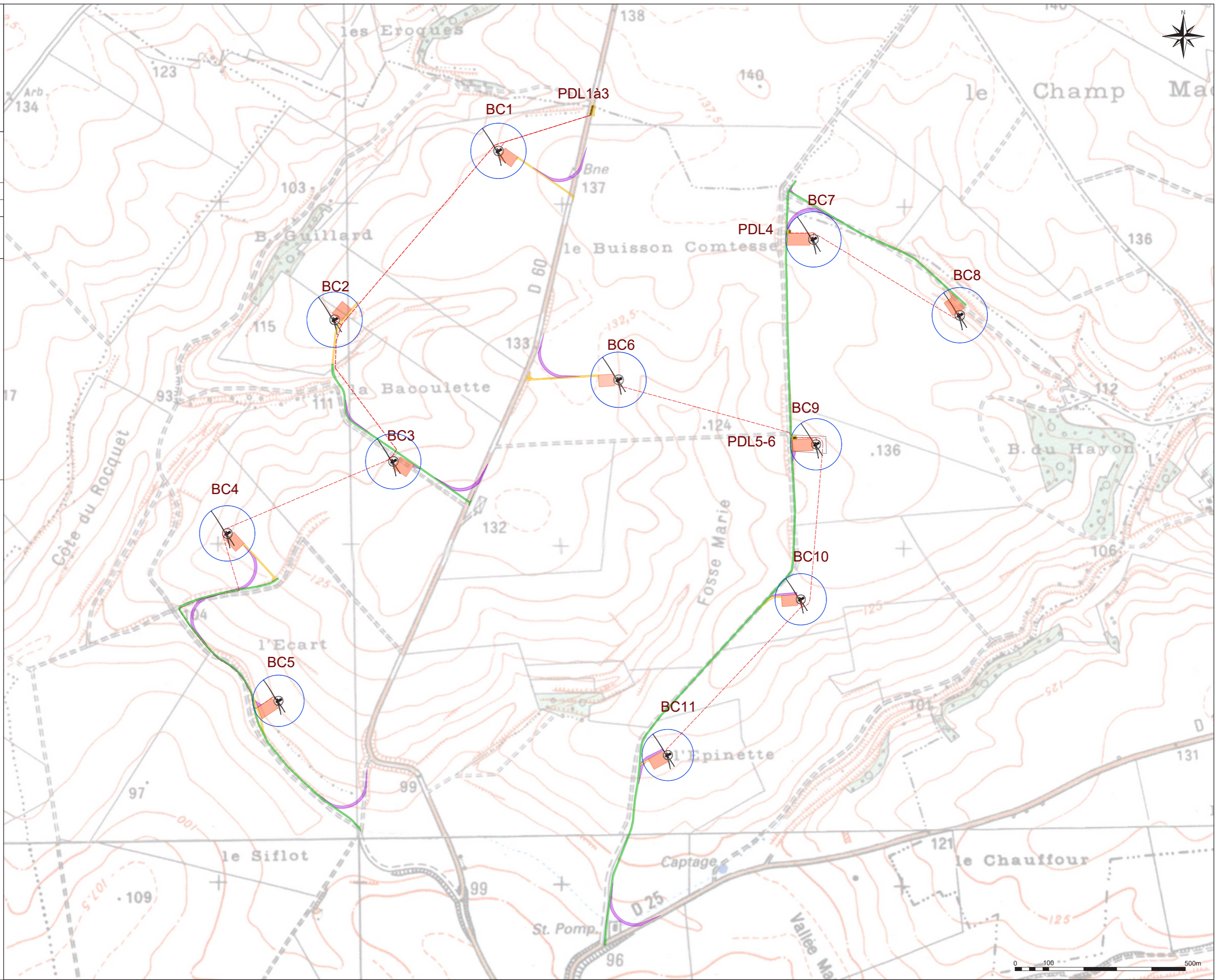





-  Eoliennes du projet
-  Poste de livraison
-  Voirie à créer
-  Voirie temporaire
-  Voirie à renforcer
-  Raccordement 20kV
-  C — C' Coupes de terrain





D RIEZ

AU 5
Plan de masse

-  Eoliennes du projet
-  Poste de livraison
-  Plateforme de montage
-  Voirie à créer
-  Voirie temporaire
-  Voirie à renforcer
-  Raccordement 20kV
-  Coupes de terrain

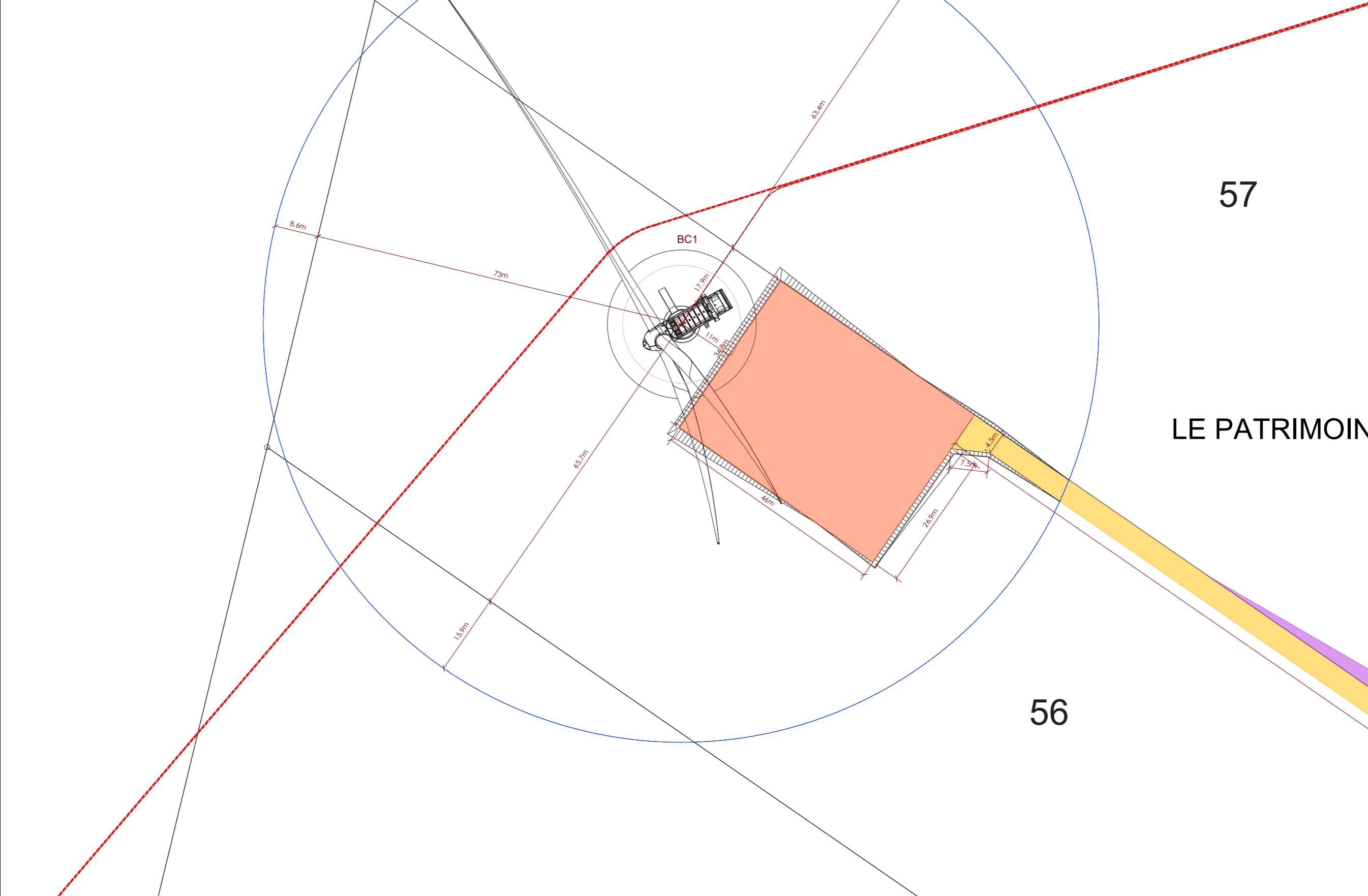
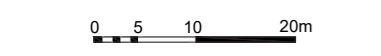

57

LE PATRIMOIN

56

AU 5
Plan de masse

 Eoliennes du projet

 Poste de livraison

 Plateforme de montage

 Voirie à créer

 Voirie temporaire

 Voirie à renforcer

 Raccordement 20kV

 C—C' Coupes de terrain

0 5 10 20m

2



LE PATRIMOINE

56

201m

R 171m

Sissonne

AU 5
Plan de masse

 Eoliennes du projet

 Poste de livraison

 Plateforme de montage

 Voirie à créer

 Voirie temporaire

 Voirie à renforcer

 Raccordement 20kV

 Coupes de terrain

0 5 10 20m

3







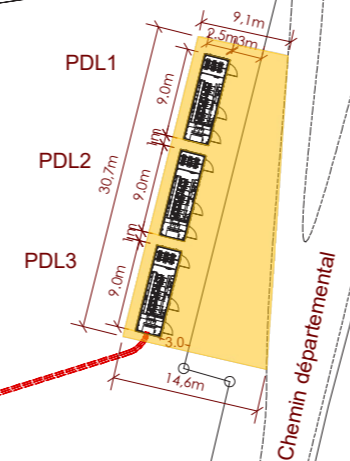

14

14

57







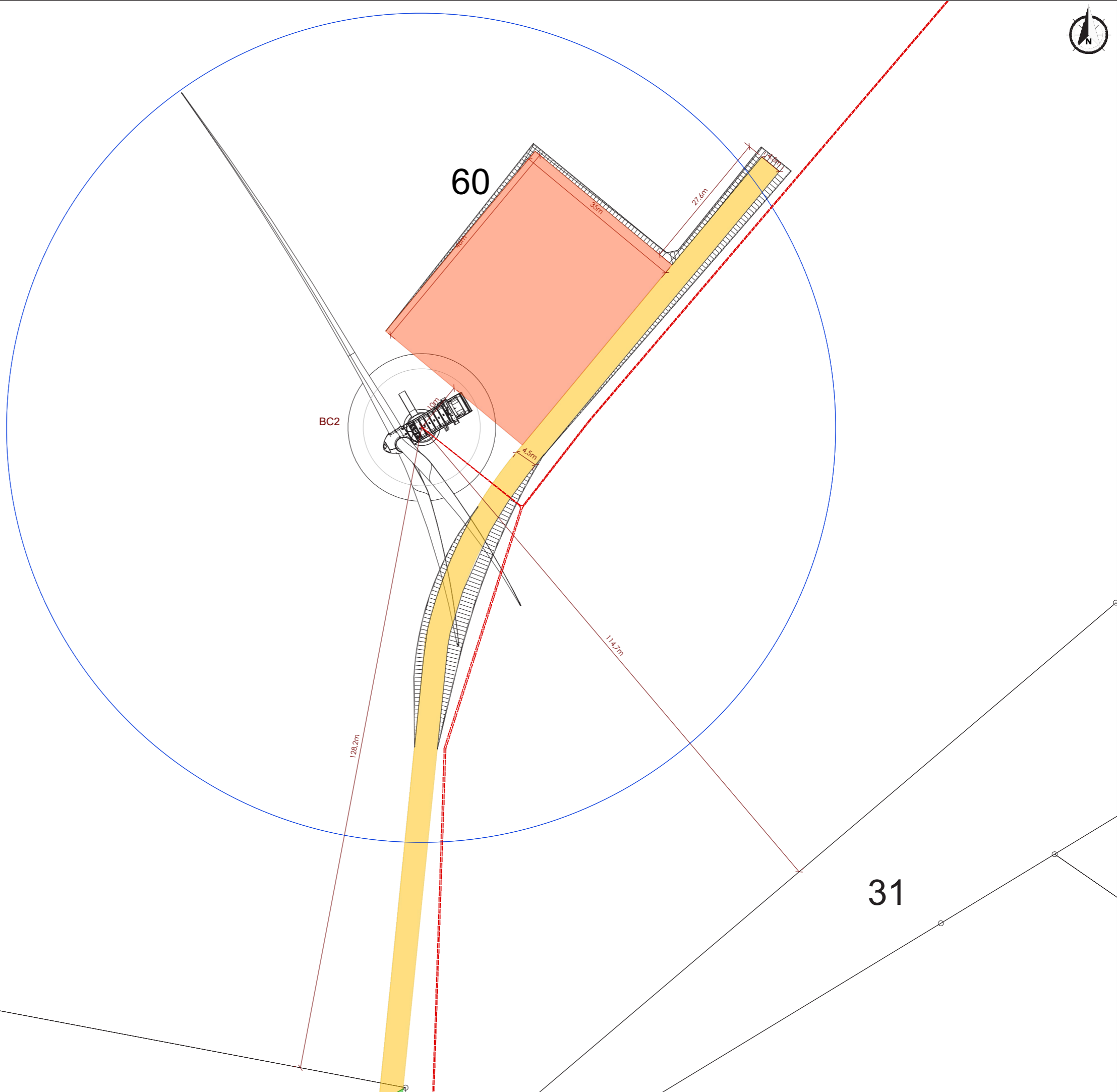
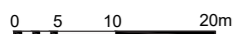



AU 5
Plan de masse

-  Eoliennes du projet
-  Poste de livraison
-  Plateforme de montage
-  Voirie à créer
-  Voirie temporaire
-  Voirie à renforcer
-  Raccordement 20kV
-  Coupes de terrain



AU 5
Plan de masse

-  Eoliennes du projet
-  Poste de livraison
-  Plateforme de montage
-  Voirie à créer
-  Voirie temporaire
-  Voirie à renforcer
-  Raccordement 20kV
-  Coupes de terrain

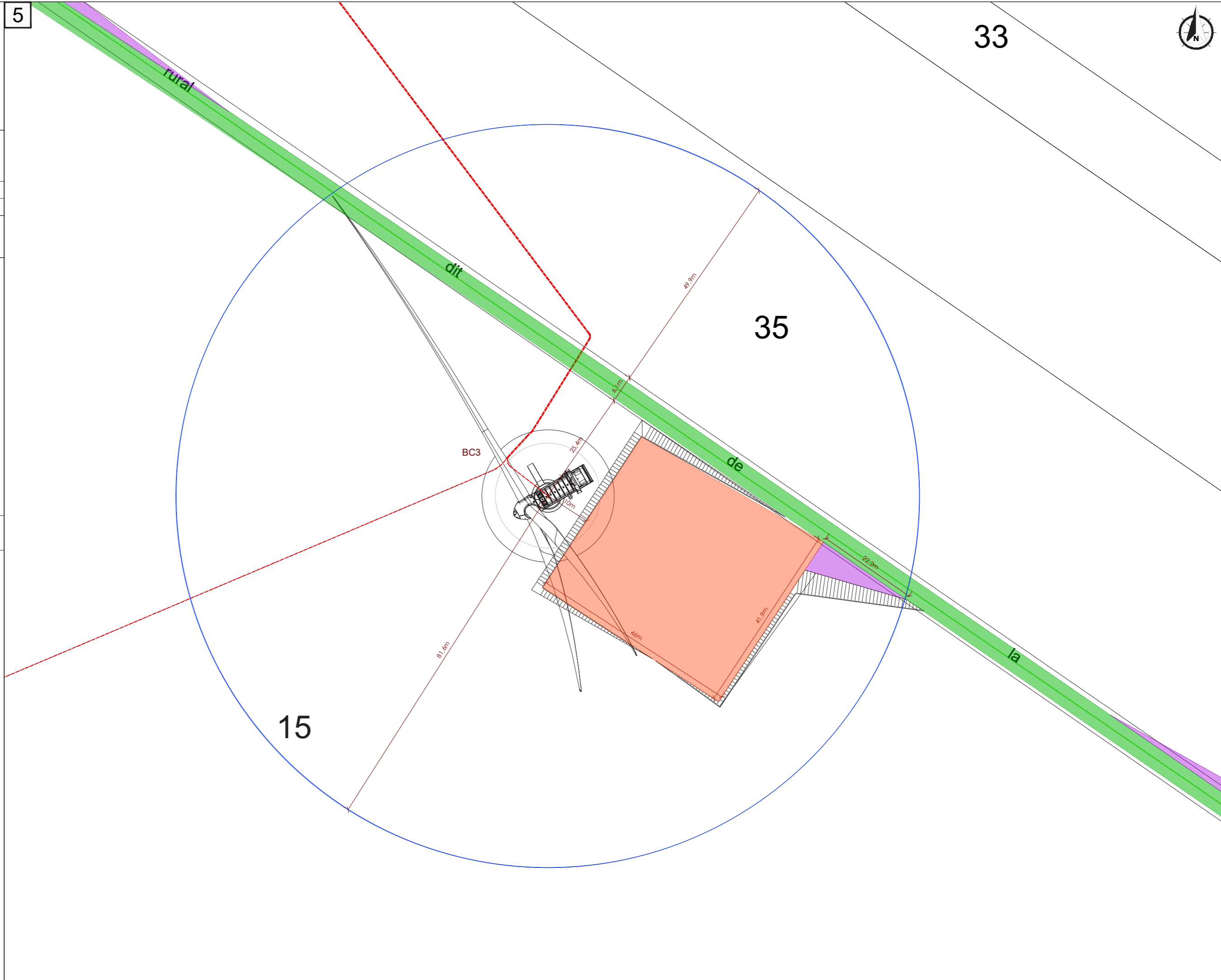
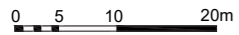

AU 5
Plan de masse

 Eoliennes du projet

 Poste de livraison

 Plateforme de montage

 Voirie à créer

 Voirie temporaire

 Voirie à renforcer

 Raccordement 20kV

 Coupes de terrain

0 5 10 20m

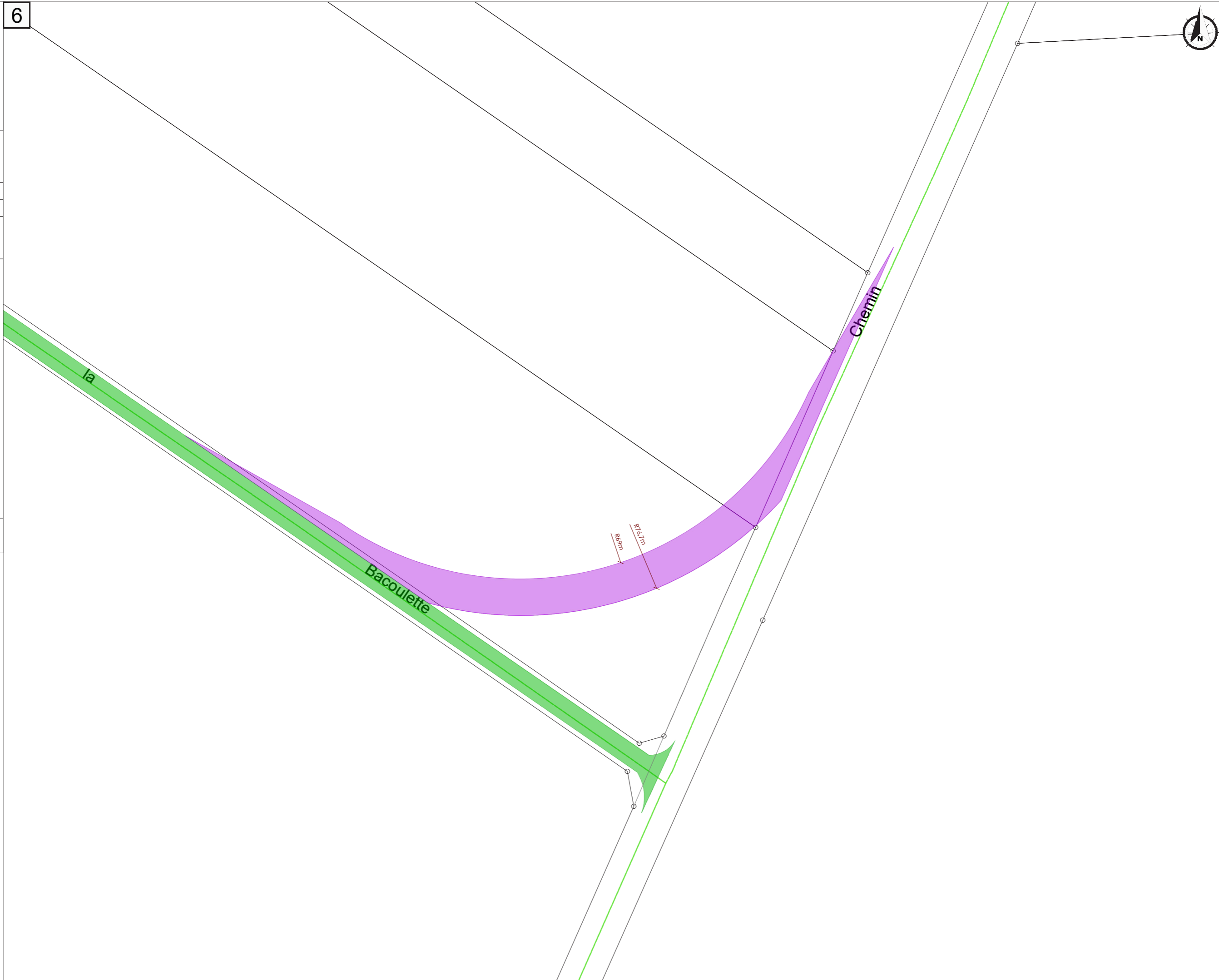

AU 5
Plan de masse

 Eoliennes du projet

 Poste de livraison

 Plateforme de montage

 Voirie à créer

 Voirie temporaire

 Voirie à renforcer

 Raccordement 20kV

 Coupes de terrain

0 5 10 20m



7

35

AU-DESSUS DU JARDIN ROND

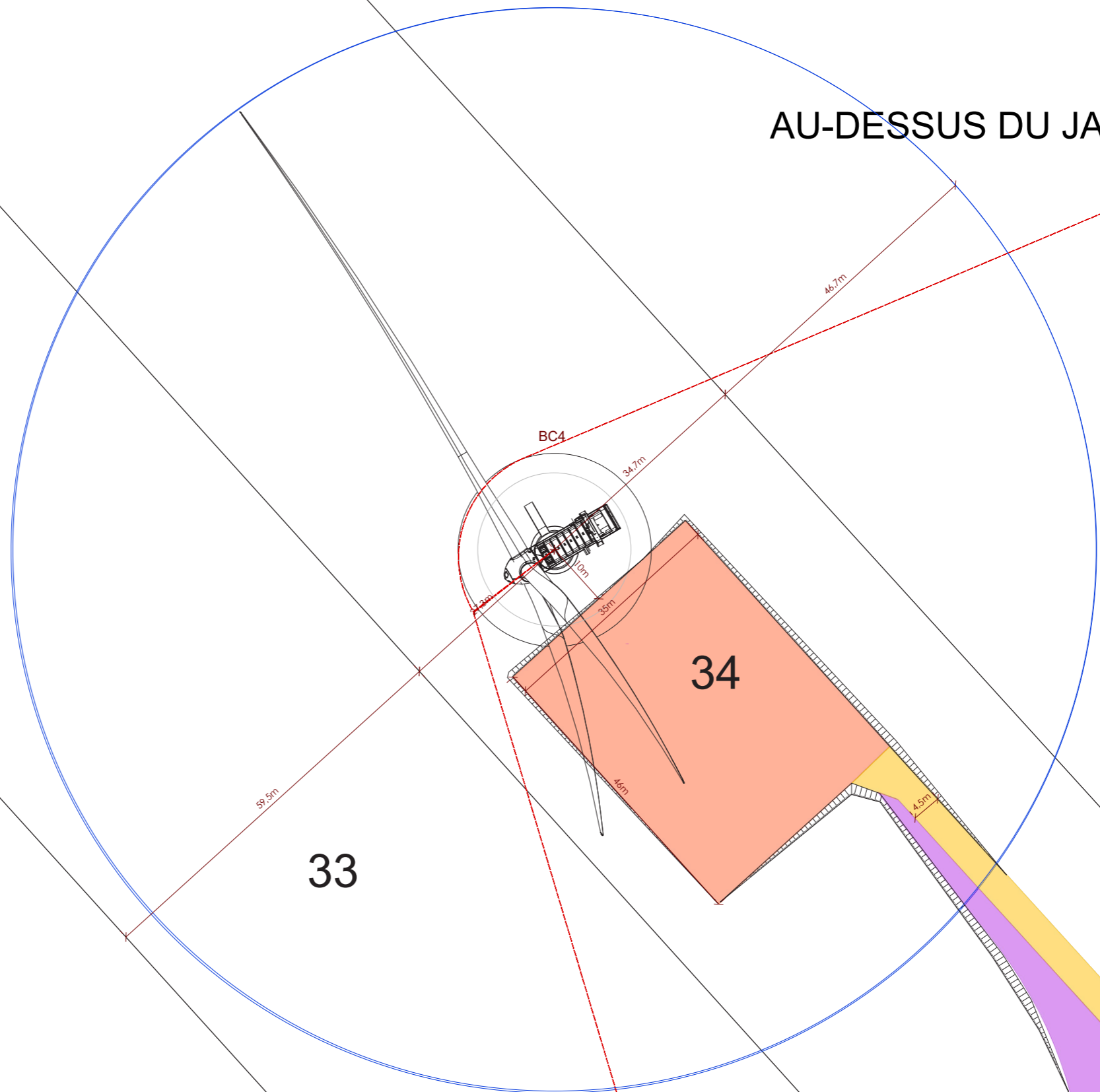

33

34

26







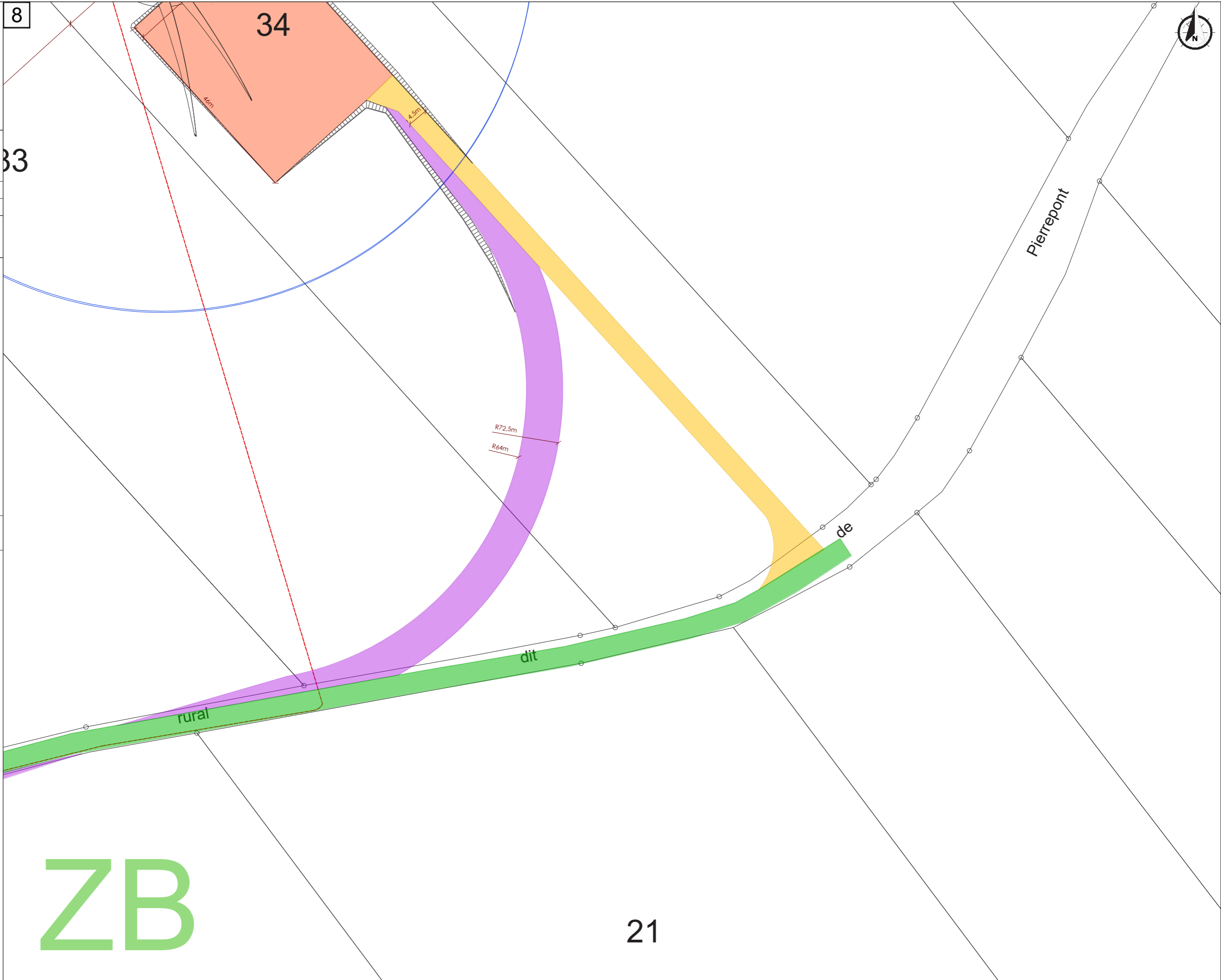
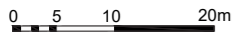

32

AU 5
Plan de masse

-  Eoliennes du projet
-  Poste de livraison
-  Plateforme de montage
-  Voirie à créer
-  Voirie temporaire
-  Voirie à renforcer
-  Raccordement 20kV
-  Coupes de terrain



AU 5
Plan de masse

-  Eoliennes du projet
-  Poste de livraison
-  Plateforme de montage
-  Voirie à créer
-  Voirie temporaire
-  Voirie à renforcer
-  Raccordement 20kV
-  Coupes de terrain

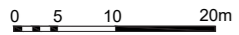

10
ND

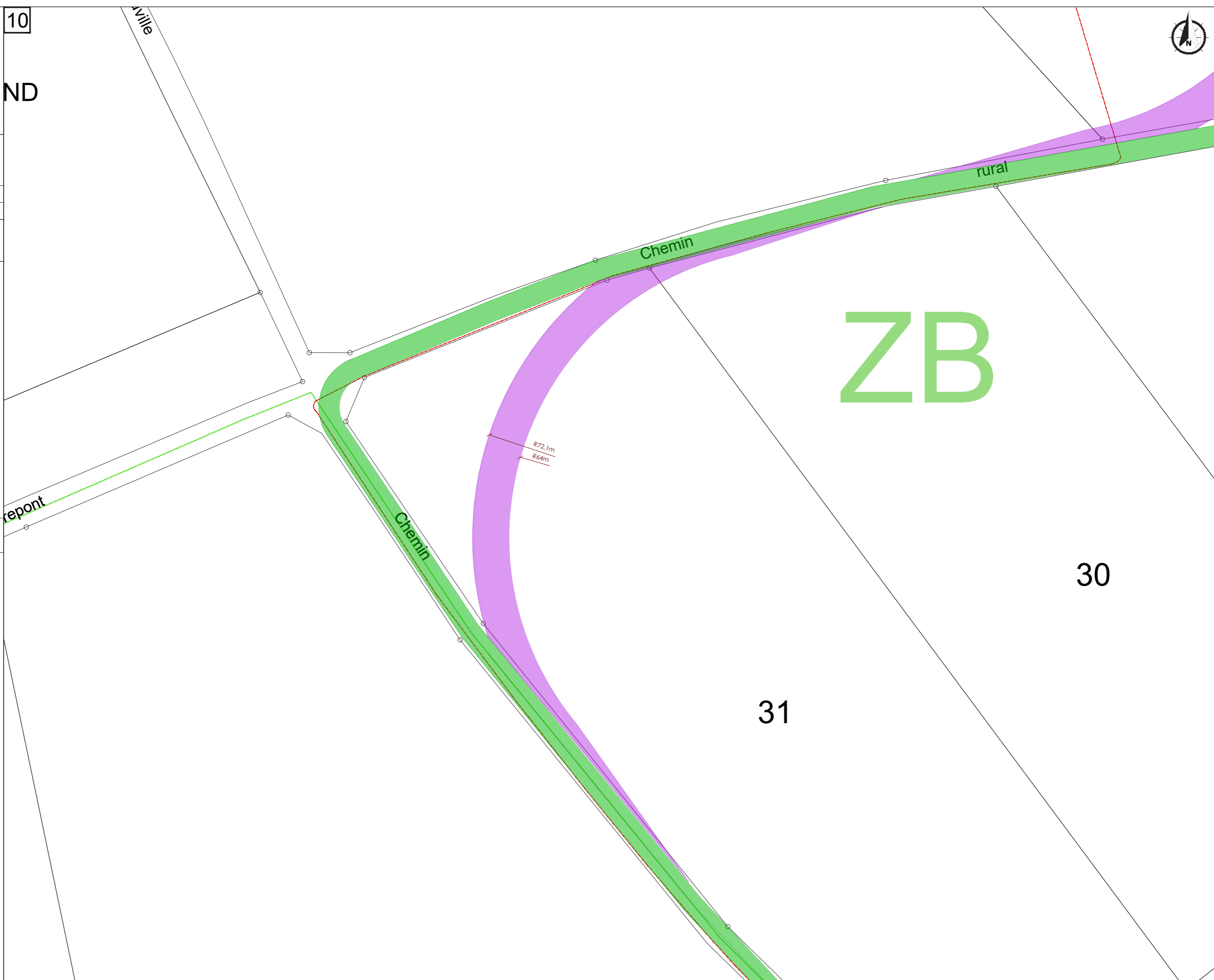

28

AU 5
Plan de masse



Eoliennes du projet



Poste de livraison

Plateforme de montage

Voirie à créer

Voirie temporaire

Voirie à renforcer

Raccordement 20kV

C—C' Coupes de terrain

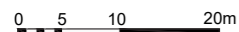

11

20



28

L'ECART

BC5

52.3m

35m

4.5m

de

AU 5
Plan de masse

 Eoliennes du projet

 Poste de livraison

 Plateforme de montage

 Voirie à créer

 Voirie temporaire

 Voirie à renforcer

 Raccordement 20kV







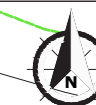

 Coupes de terrain

0 5 10 20m

12



AU 5
Plan de masse

-  Eoliennes du projet
-  Poste de livraison
-  Plateforme de montage
-  Voirie à créer
-  Voirie temporaire
-  Voirie à renforcer
-  Raccordement 20kV
-  Coupes de terrain

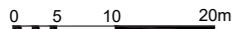

13

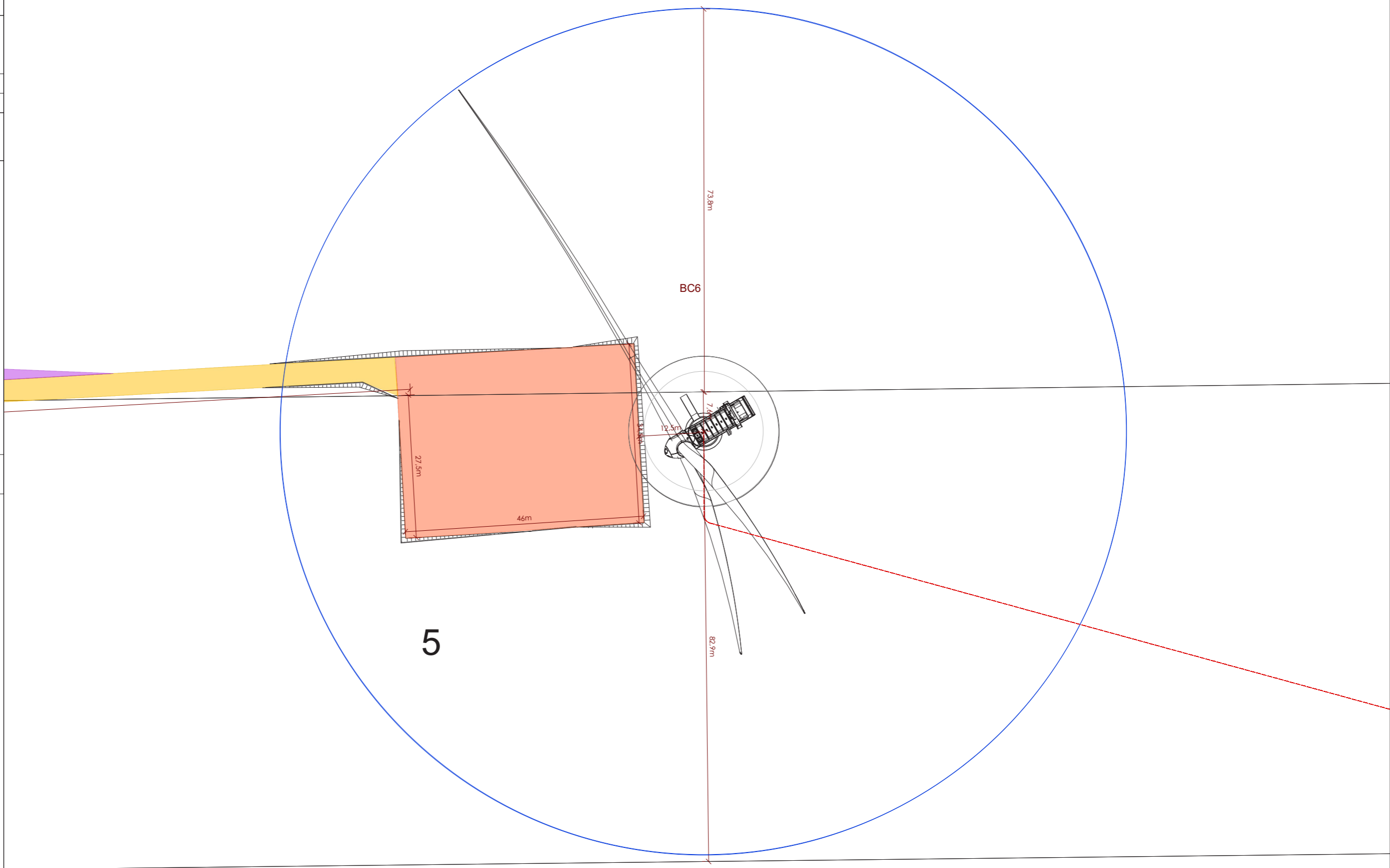
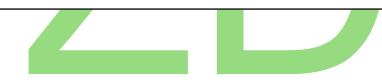

5

AU 5
Plan de masse

 Eoliennes du projet

 Poste de livraison

 Plateforme de montage

 Voirie à créer

 Voirie temporaire

 Voirie à renforcer

 Raccordement 20kV

 Coupes de terrain



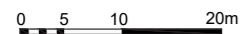





0 5 10 20m



14



AU 5
Plan de masse

-  Eoliennes du projet
-  Poste de livraison
-  Plateforme de montage
-  Voirie à créer
-  Voirie temporaire
-  Voirie à renforcer
-  Raccordement 20kV
-  Coupes de terrain

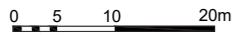



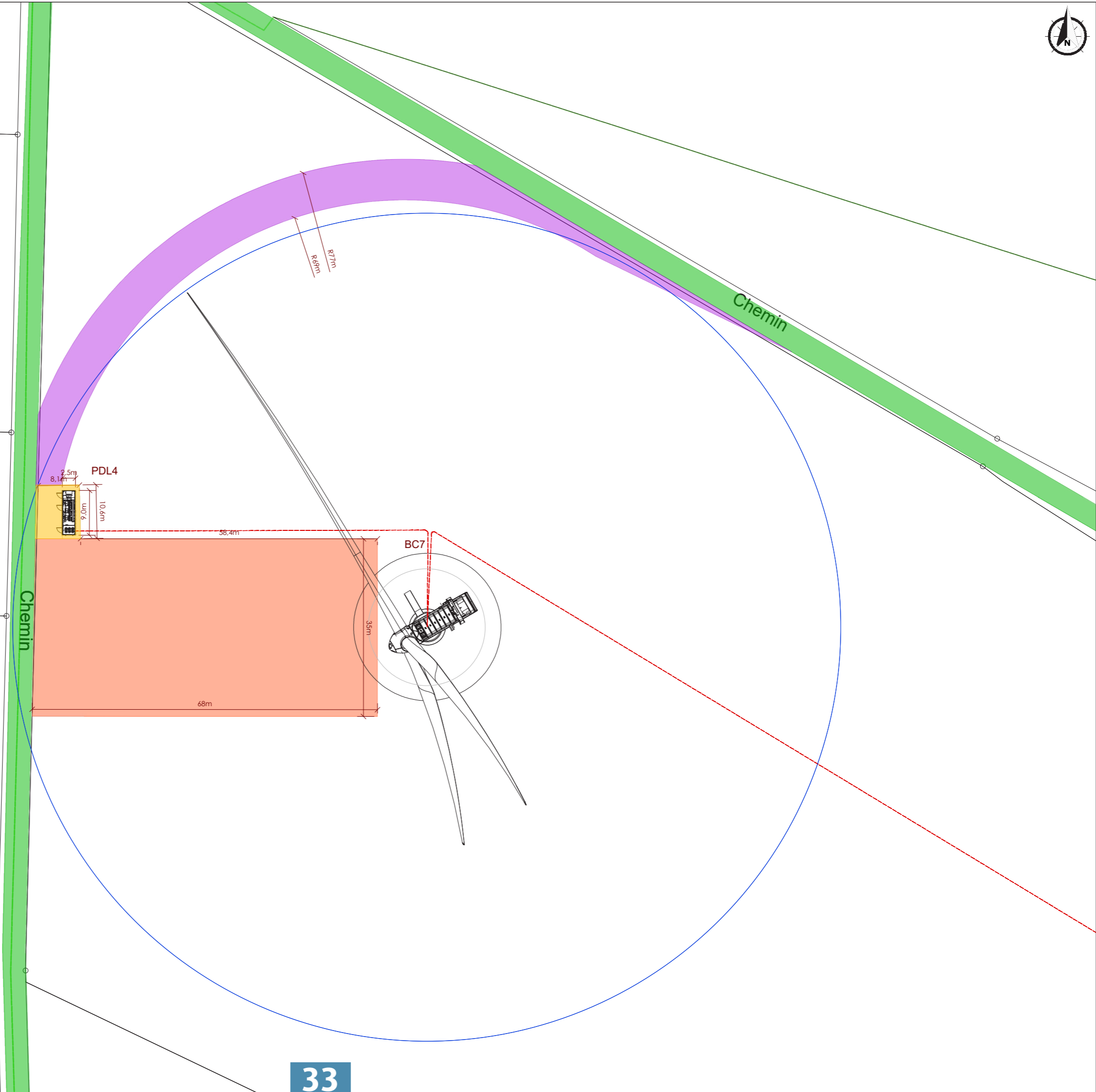

15



33

AU 5
Plan de masse

-  Eoliennes du projet
-  Poste de livraison
-  Plateforme de montage
-  Voirie à créer
-  Voirie temporaire
-  Voirie à renforcer
-  Raccordement 20kV
-  Coupes de terrain

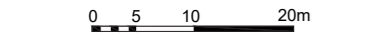

17



MARLE

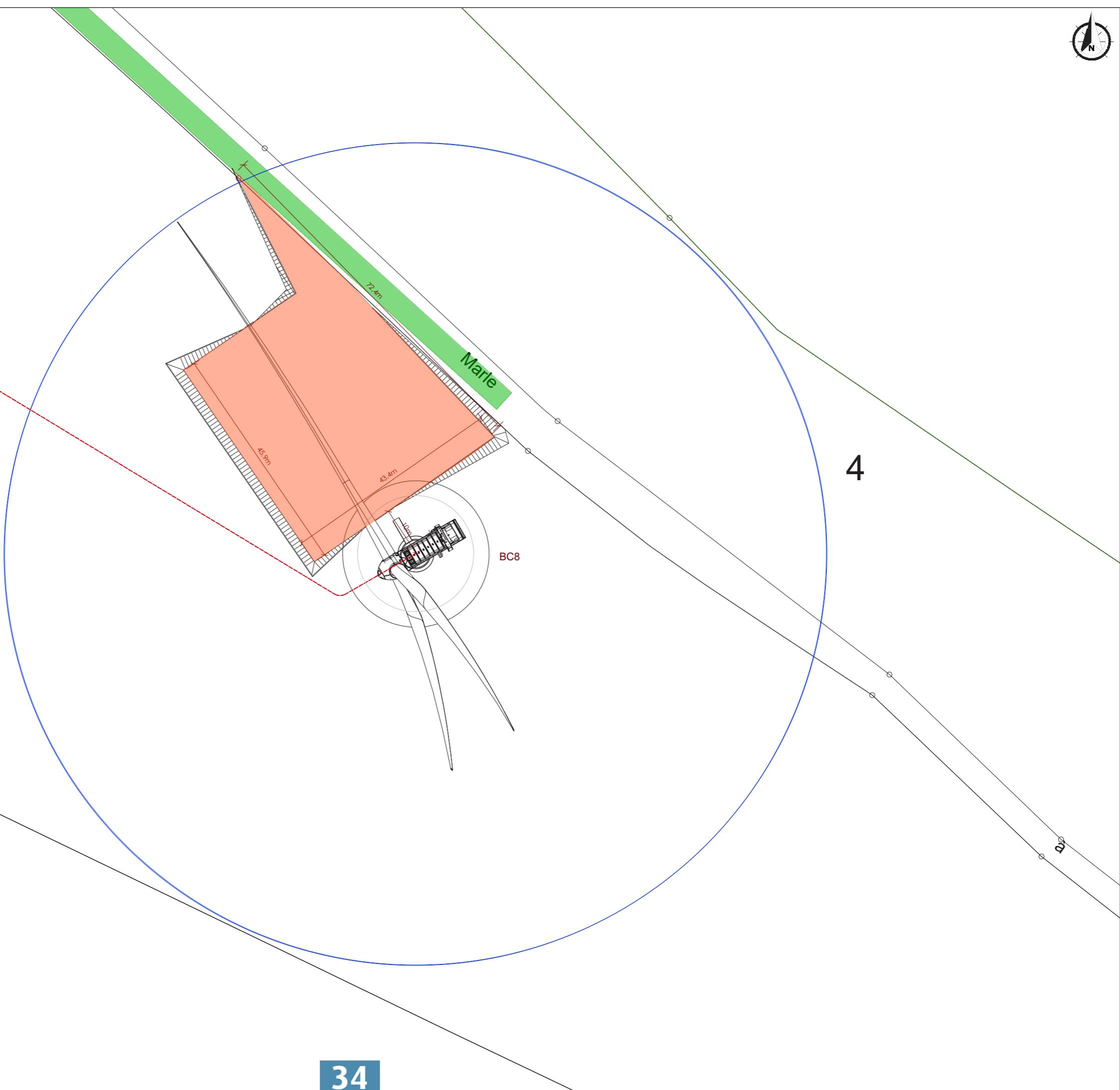

AU 5 Plan de masse

 Eoliennes du projet

 Poste de livraison

 Plateforme de montage

 Voirie à créer

 Voirie temporaire

 Voirie à renforcer

 Raccordement 20kV

 C — C' Coupes de terrain

 0 5 10 20m

18

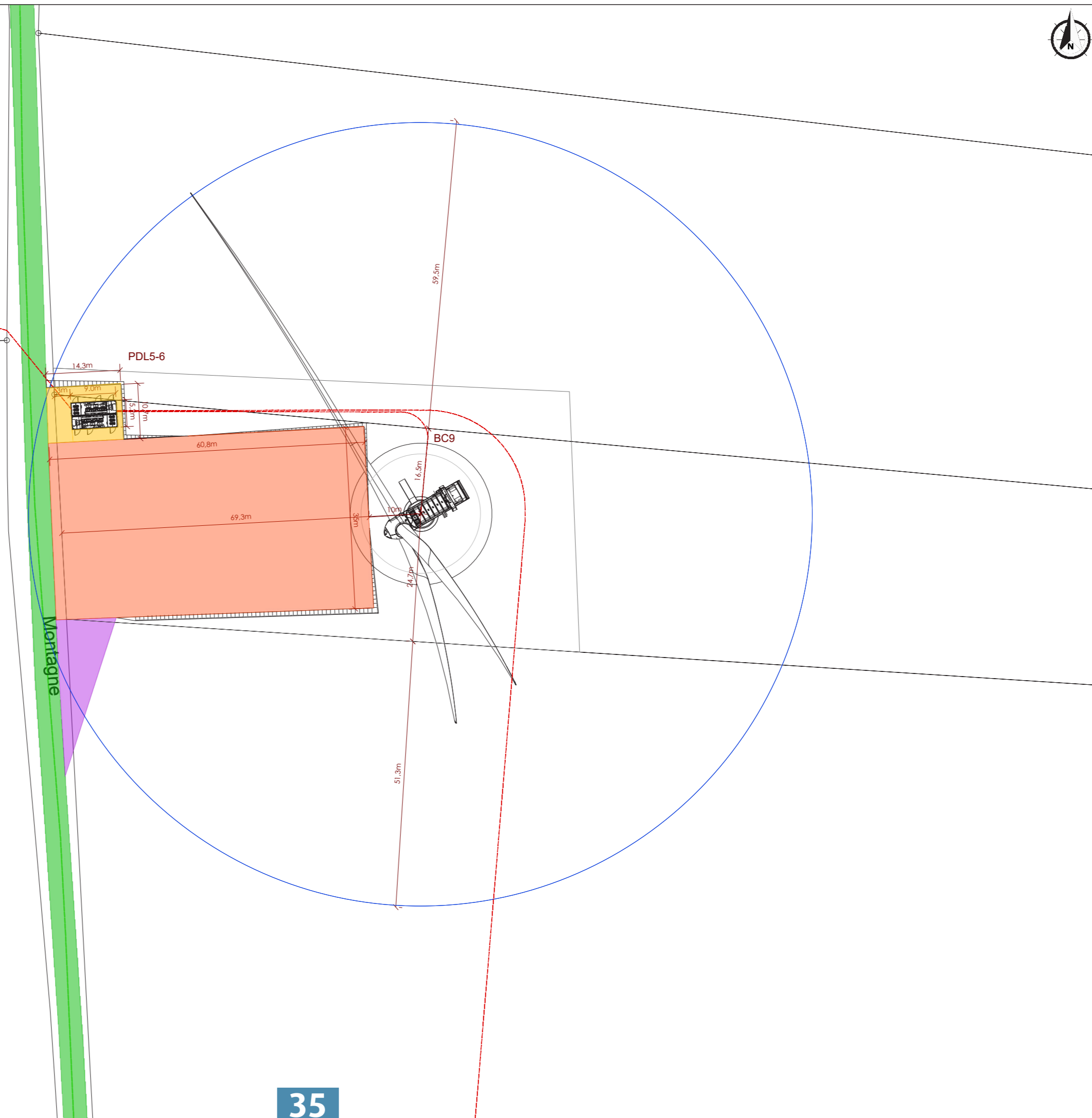

AU 5
Plan de masse

-  Eoliennes du projet
-  Poste de livraison
-  Plateforme de montage
-  Voirie à créer
-  Voirie temporaire
-  Voirie à renforcer
-  Raccordement 20kV
-  Coupes de terrain

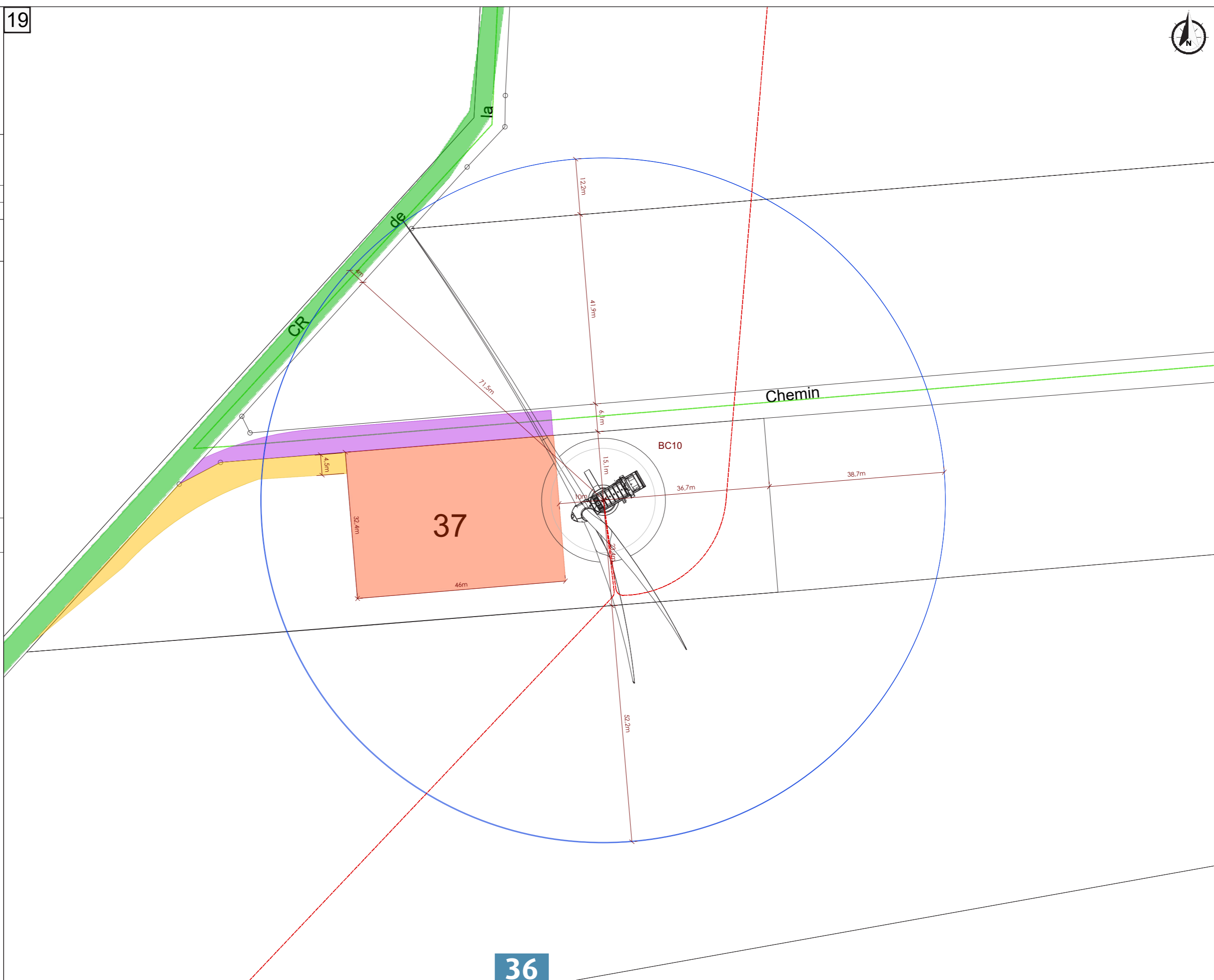
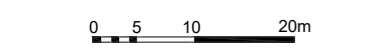

AU 5
Plan de masse

 Eoliennes du projet

 Poste de livraison

 Plateforme de montage

 Voirie à créer

 Voirie temporaire

 Voirie à renforcer

 Raccordement 20kV

 C — C' Coupes de terrain

0 5 10 20m

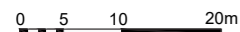

20



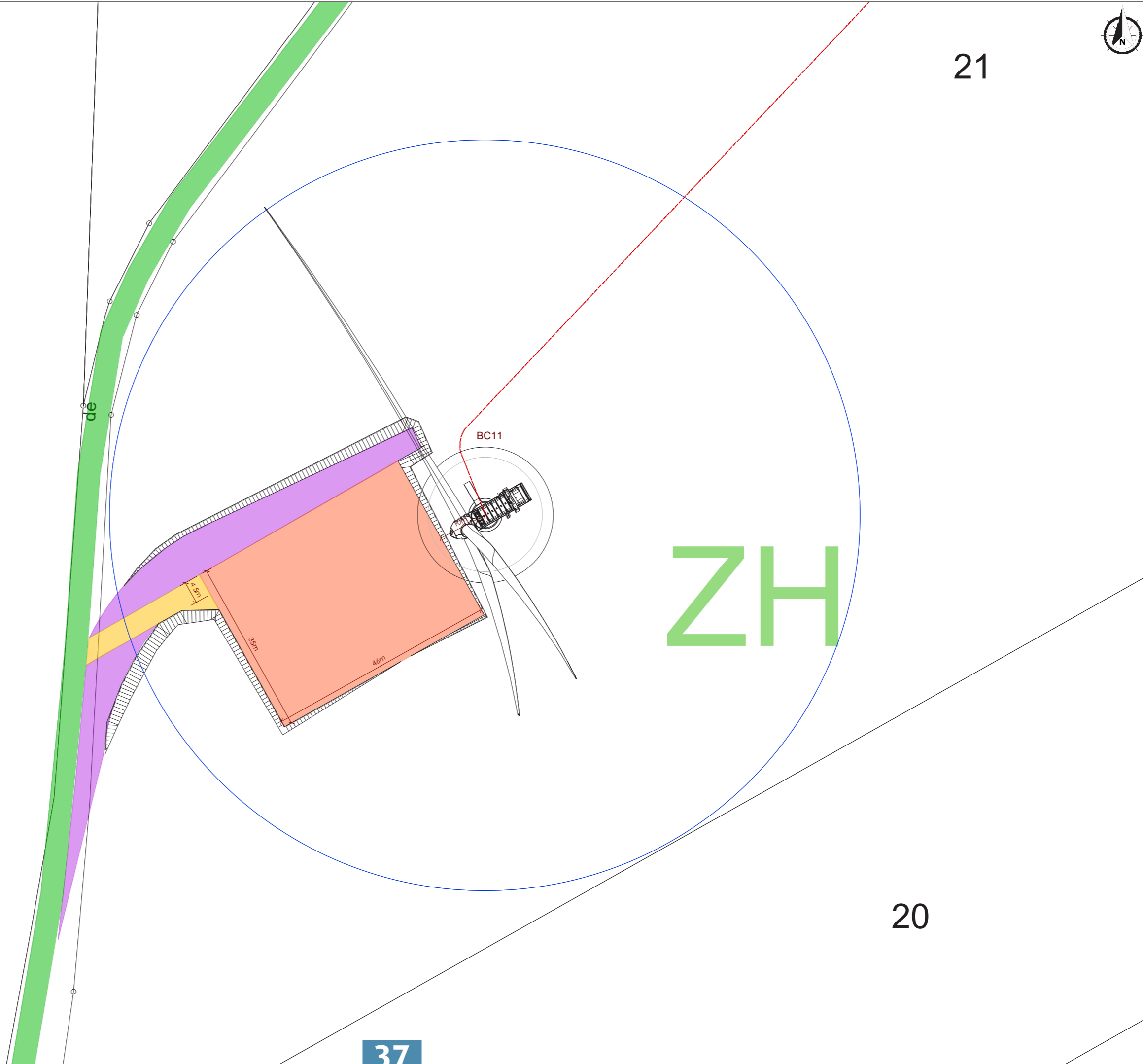





21



20

37

AU 5
Plan de masse

-  Eoliennes du projet
-  Poste de livraison
-  Plateforme de montage
-  Voirie à créer
-  Voirie temporaire
-  Voirie à renforcer
-  Raccordement 20kV
-  Coupes de terrain

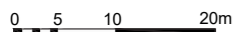





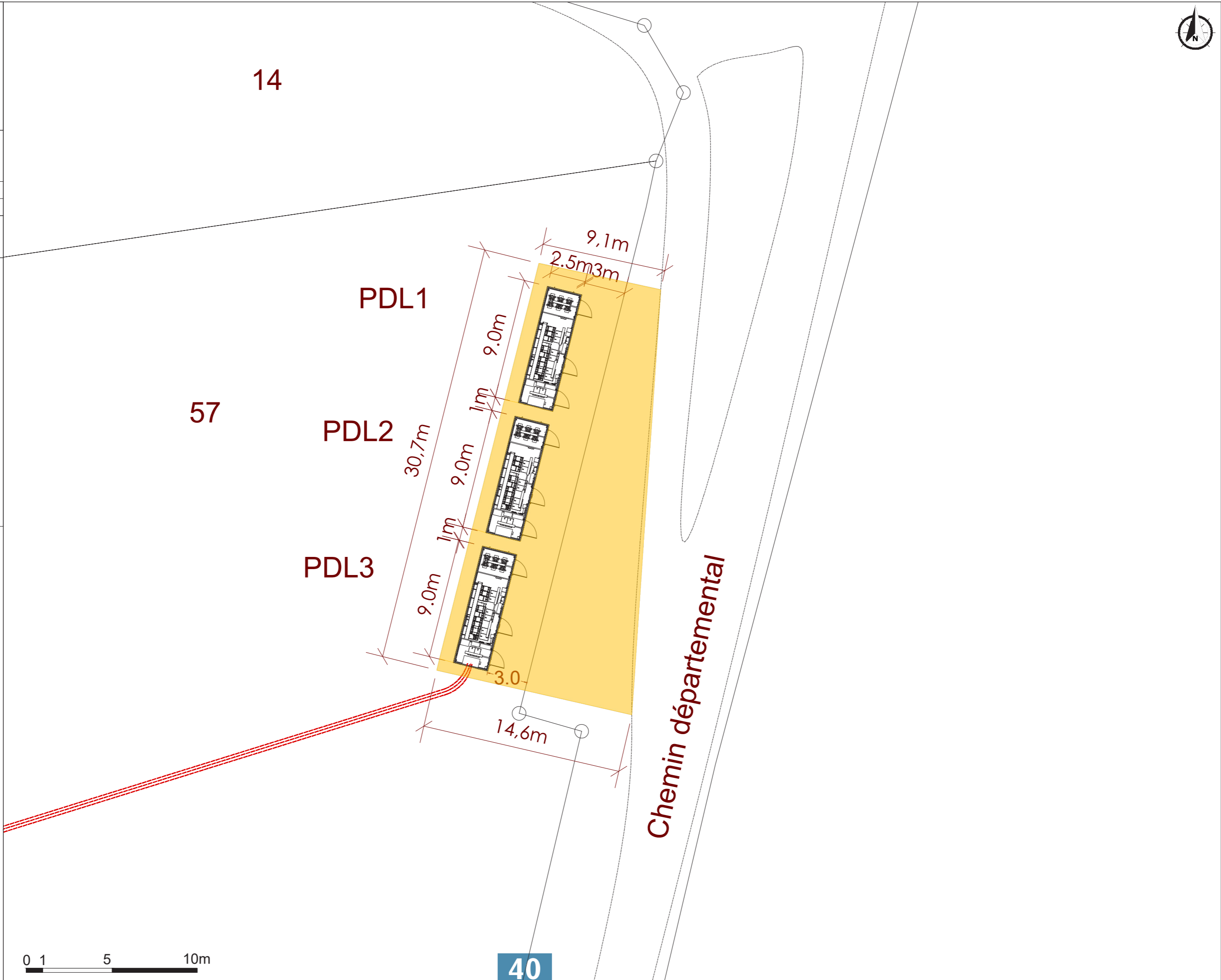



AU 5
Plan de masse

-  Eoliennes du projet
-  Poste de livraison
-  Plateforme de montage
-  Voirie à créer
-  Voirie temporaire
-  Voirie à renforcer
-  Raccordement 20kV
-  Coupes de terrain





AU 5
Plan de masse

-  Eoliennes du projet
-  Poste de livraison
-  Plateforme de montage
-  Voirie à créer
-  Voirie temporaire
-  Voirie à renforcer
-  Raccordement 20kV
-  Coupes de terrain

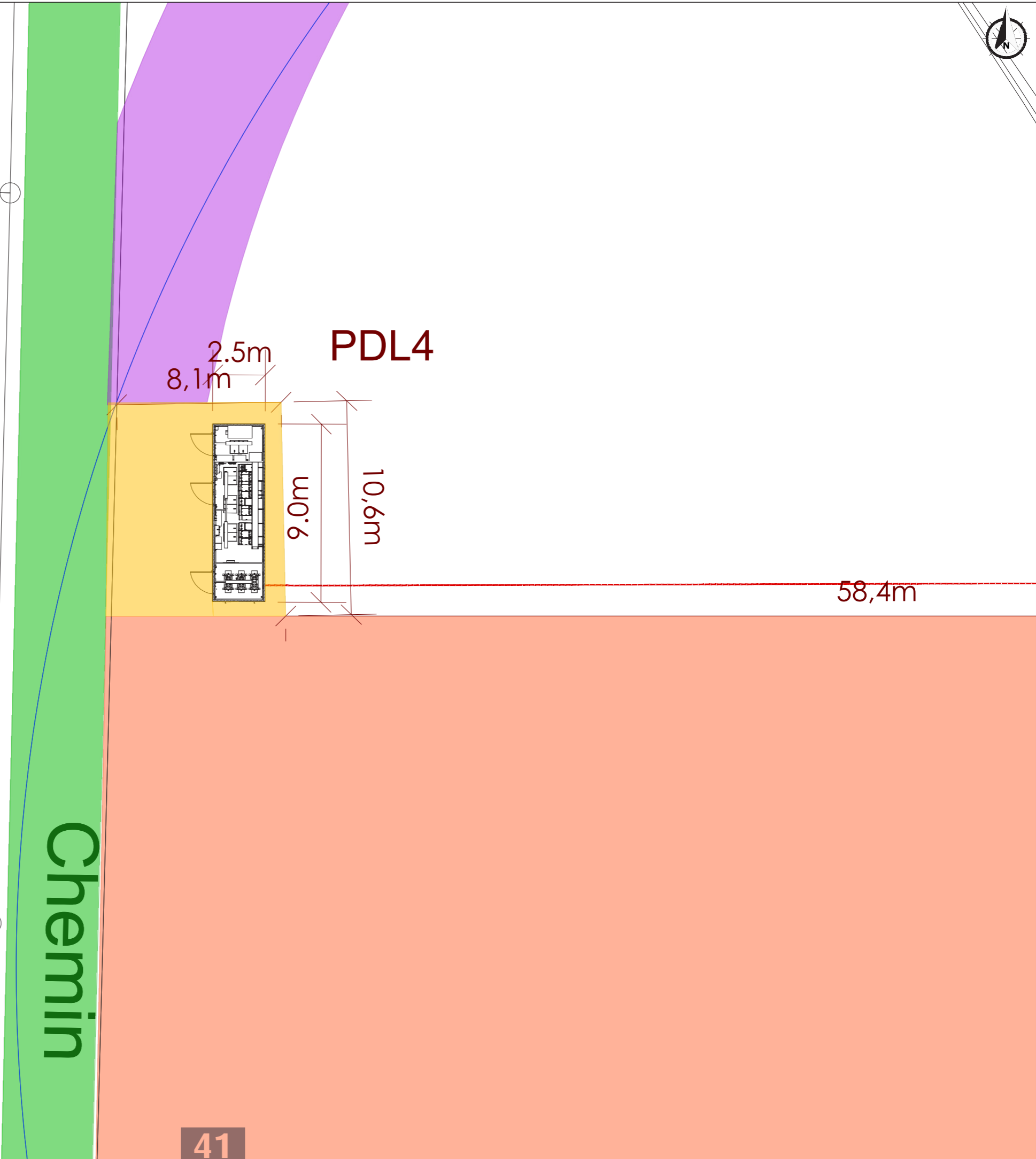

AU 5
Plan de masse

Eoliennes du projet



Poste de livraison



Plateforme de montage



Voirie à créer



Voirie temporaire



Voirie à renforcer



Raccordement 20kV



Coupes de terrain

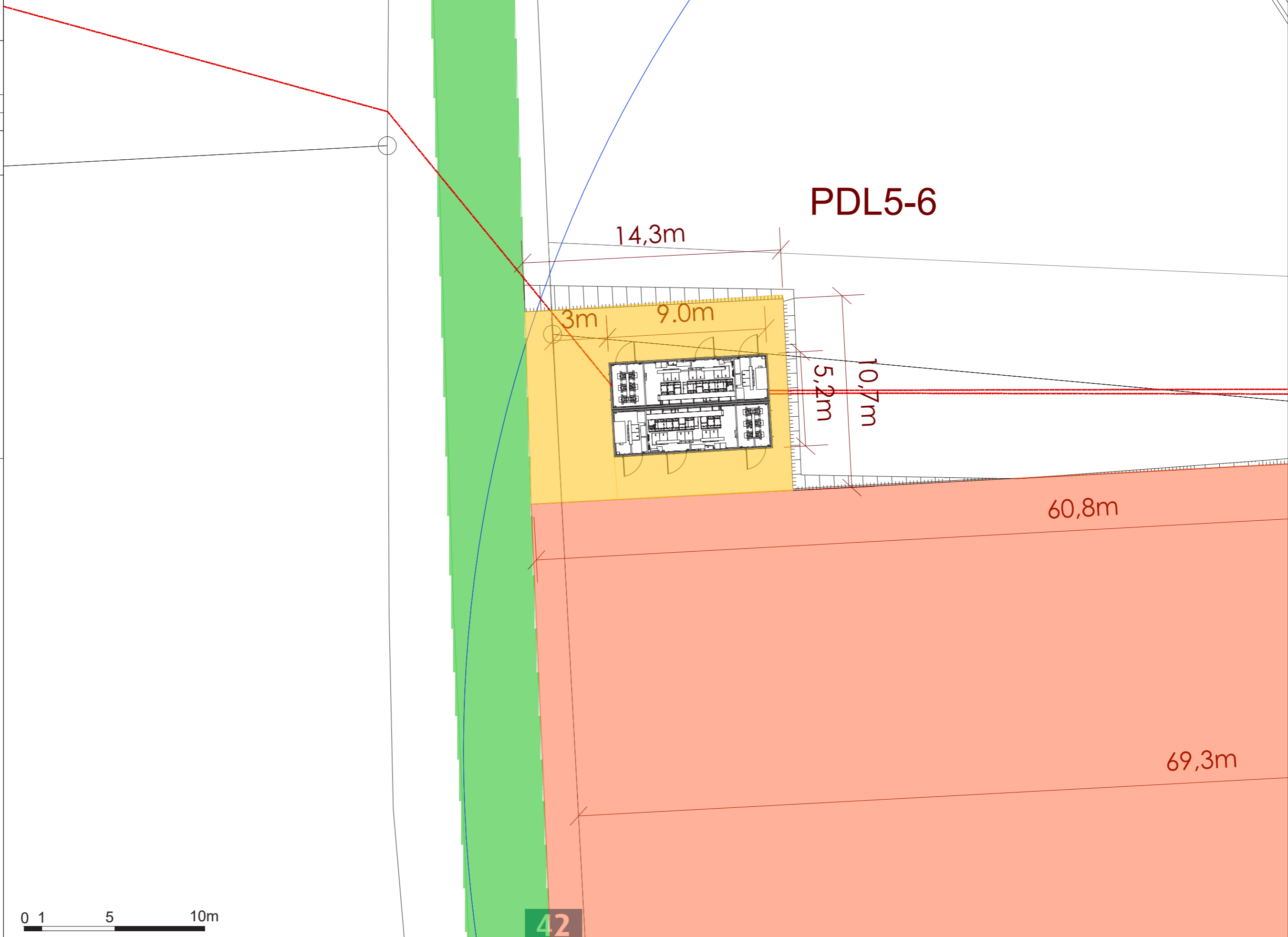

V150 - Rotor@105m
 Eoliennes BC5 - BC9 - BC10 - BC11

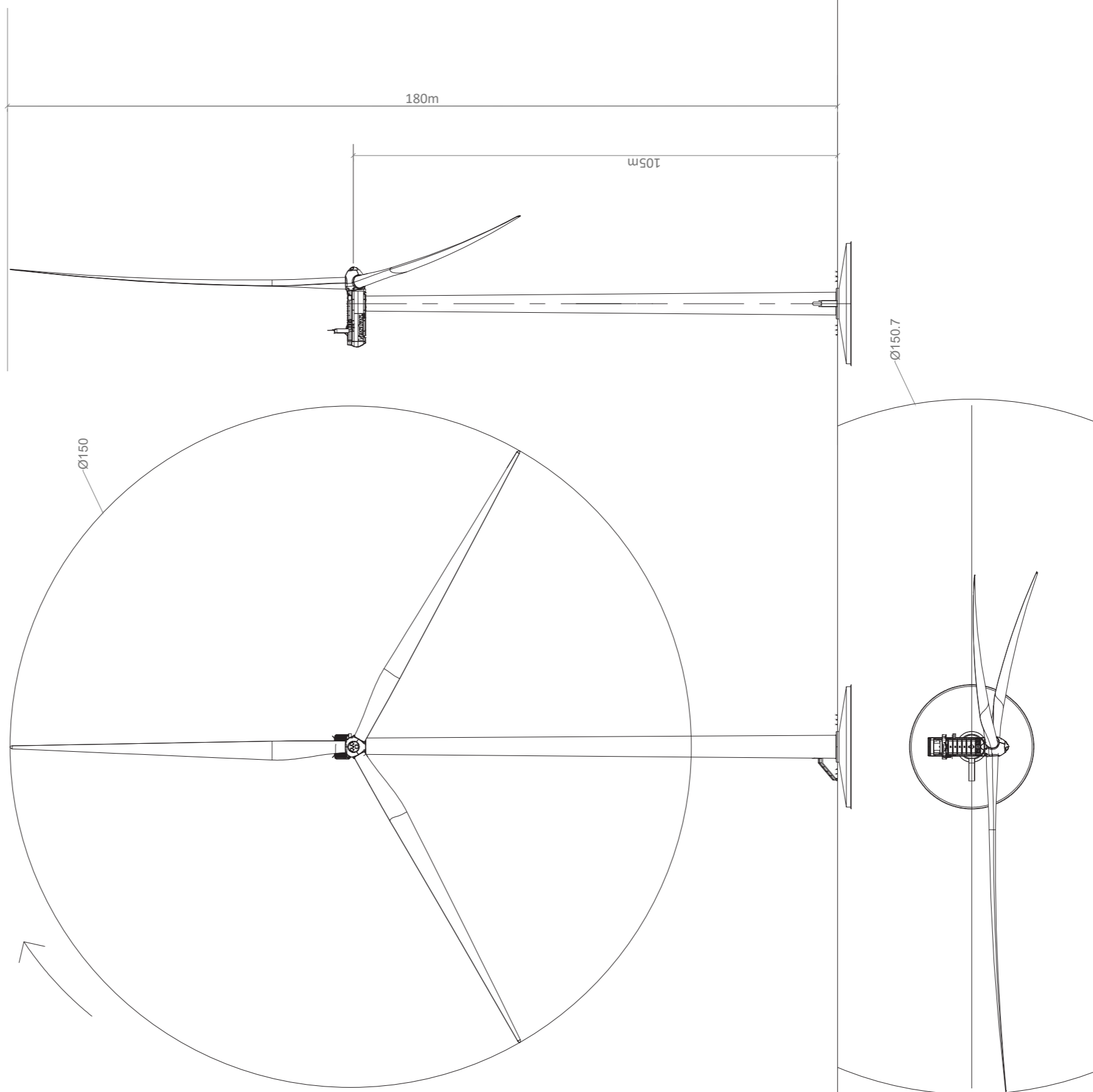

V162 - Rotor@125m
 Eoliennes BC1 - BC2 - BC3 - BC4 - BC6 - BC7 - BC8

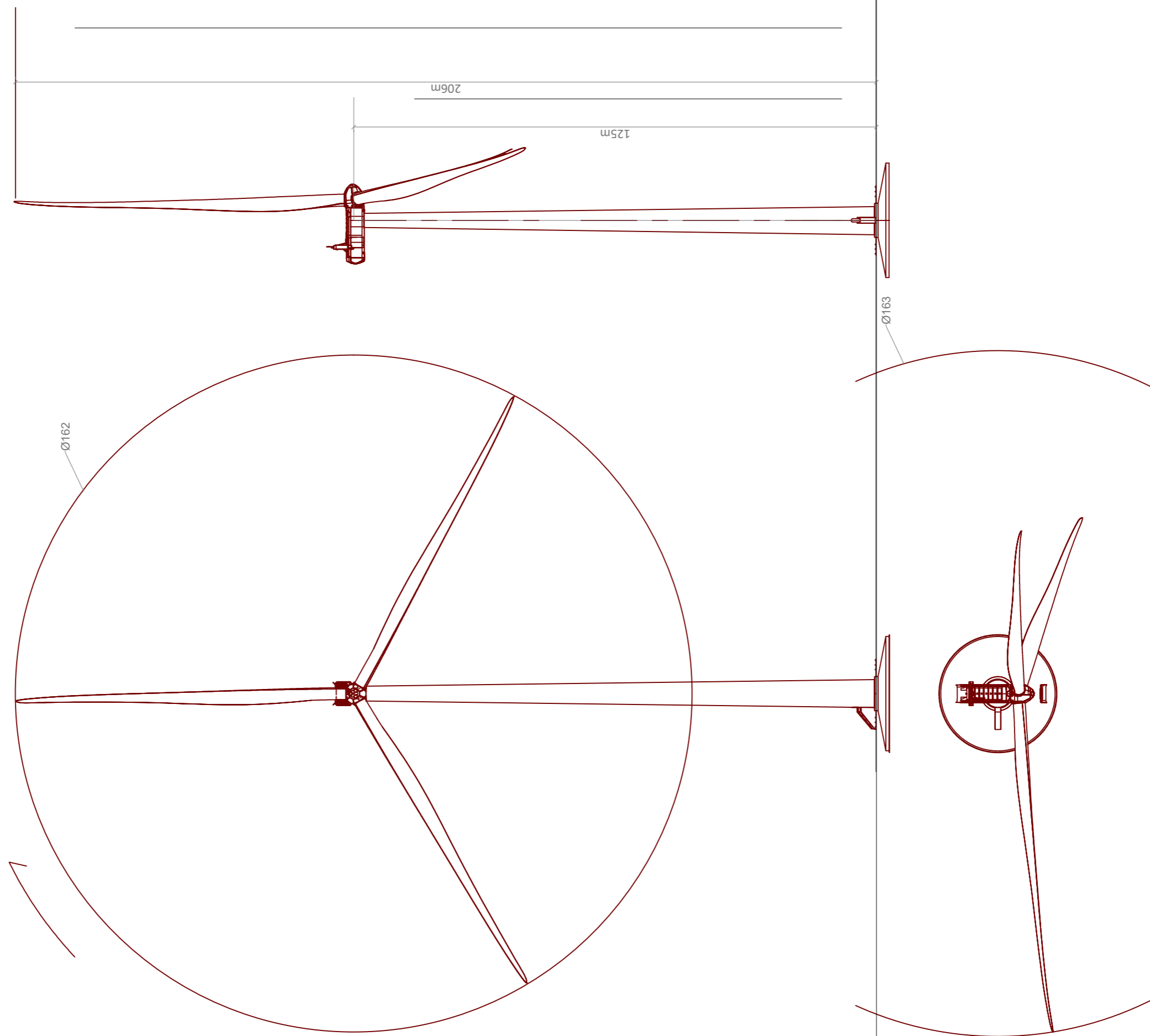

AU10.2 - 10.3
Plan de masse
Plan de facades
Postes de livraison

